

Island Hood
IZL106



IMPORTANT SAFETY INFORMATION

****Read the complete manual carefully before installation****

Intended for Domestic Kitchen Use Only

Warnings:

TO REDUCE THE RISK OF FIRE, ELECTRICAL SHOCK OR PERSONAL INJURY, PLEASE OBSERVE THE FOLLOWING:

1. Installation and electrical work must be done by a qualified person in accordance with all applicable codes and standards
2. If the supply cord is damaged, it must be replaced by the manufacturer, its service agent or a similarly qualified person to avoid a hazard. Any modifications that may be required to the electrical system for the installation of the range hood must only be made by qualified electricians.
3. Before servicing or cleaning unit, switch power off at the service panel. Lock panel to prevent power from being switched on accidentally.
4. Use this unit only in the manner intended by the manufacturer.
5. When cutting or drilling into wall or ceiling, be careful to do not damage existing electrical wiring and other hidden utilities.
6. Ducted fans must always be vented to the outdoors.
7. This unit must be grounded.

CAUTION

1. To reduce the risk of fire and to properly exhaust air, be sure to duct air outside. Do not vent exhaust air into spaces within walls or ceiling or into attics, crawl spaces or garages.
2. Take care when using cleaning agents or detergents.
3. Avoid using food products that produce flames under the range hood.
4. The range hood must only be used for the exhaust of cooking fumes in home kitchens. The manufacturer disclaims all liability for any other use of the appliance.
5. Two installers are recommended because of the large size and weight of this hood.
6. Use with approved cord-connection kit only.
7. Please read specification label on product for further information and requirements.

INSTALLATION INSTRUCTIONS

Before You Start...

1. Read this manual carefully and completely.
2. The range hoods conform to related appliances standards. Please check your local building codes for any additional requirements.
3. The appliance has been manufactured as class I, therefore ground connection is necessary. The range hood must be installed so that the plug is easily accessible.

Planning Your Installation

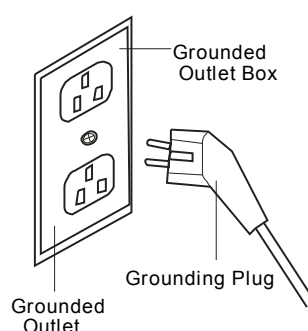

1. Measure the floor to ceiling height. This hood can be installed on walls between 8" and 9" tall.
2. Find the centre point of your opening. Mark a plumb line through this point from ceiling to your range/cook-top.
3. Check your range/cook-top User Manual for the minimum distance above your cooking surface. The minimum distance between any element or flame height and the nearest combustible surface is 61cm (24").
4. Decided where the ductwork will run between the hood and the outside. Short, straight duct runs will provide the most air flow.

Unpacking

Remove the packaging with the product in place. Cut off the packing ribbons and carefully cut open the packaging (do not cut too deeply), remove the packaging. Check that the product is free from transport damage. Any damage shall be reported immediately to the carrier or seller. Damage, faults and missing parts must be reported immediately to the seller.

Installing the Ductwork

1. Plan where the ductwork will run between the hood and the outside. The hoods exhaust vertically but can be ducted to the rear behind the chimney duct through an outside wall or vertically up through the ceiling to the roof. A short straight duct run will produce the most air flow. Length and elbows will reduce the efficiency of the blower.
2. Install a roof or wall cap. Connect a 6" round metal duct to the cap and work backwards toward the hood. Ensure joints are completely sealed with duct tape.

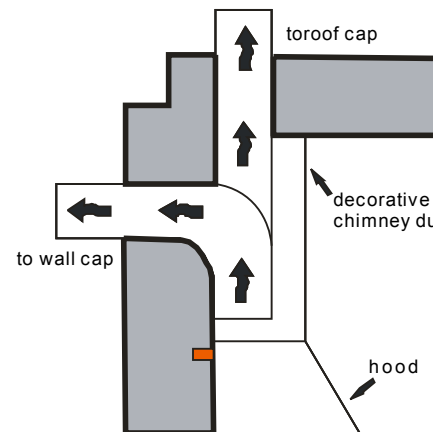

Fixing to the Wall

1. Before mounting the hood, plug in and test all functions for proper operation.
2. Removed the filters from the bottom of the hood to pre-vent damage during the installation.
3. With assistance, hold the hood temporary in position ensuring the bottom is above the minimum clearance for the cooking surface. Mark on the wall the holes for the two mounting screws.
4. Drill the holes (A) at the distances indicated. Use the appropriate screws and screw anchors for your wall type (e.g. reinforced concrete, drywall, etc.). If necessary, prepare back wall with cross framing for secure installation.
5. Mount the hood on the wall screws. Align it in a horizontal position relative to cabinets. When the hood has been adjusted, secure unit by tightening screws (A).
6. Connect a 6" aluminum duct tube (not included) to the exhaust piece using duct tape on all seals. (C)

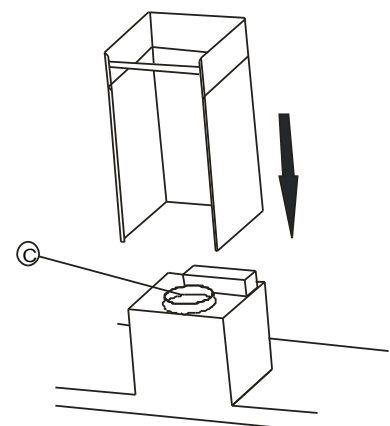
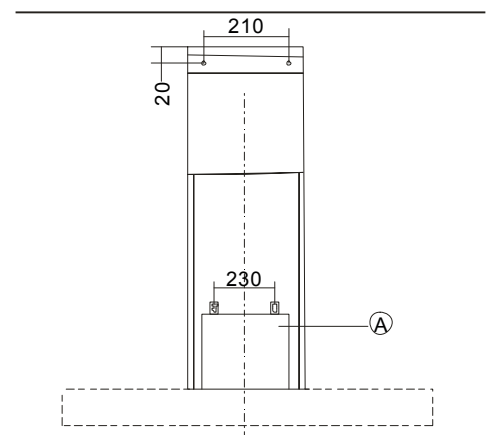

Fixing the Decorative Chimney Duct

1. Carefully losen but do not separate the telescopic chim-ney duct pieces.
2. Arrange the electrical power supply within the dimen-sions of the decorative chimney duct.
3. Adjust the width of the support bracket to match the upper duct. Fix it to the ceiling using the screws (B) so that it is centered in line with your hood and at a distance from the ceiling indicated.

Installing Guideline

Wall-Mounted

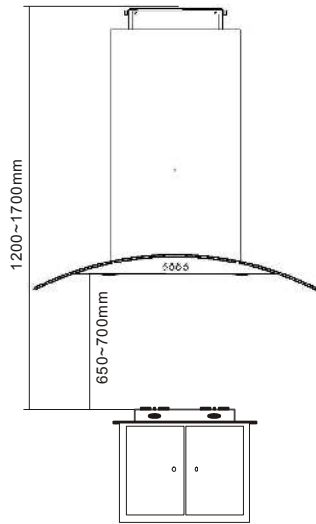

Duct-out

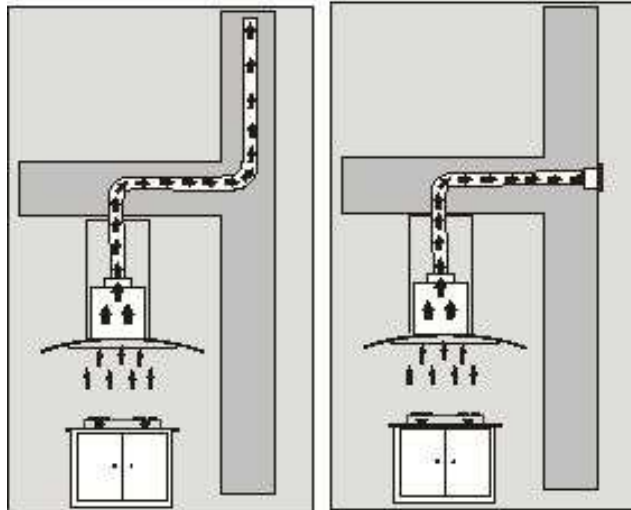

Island hood step 1

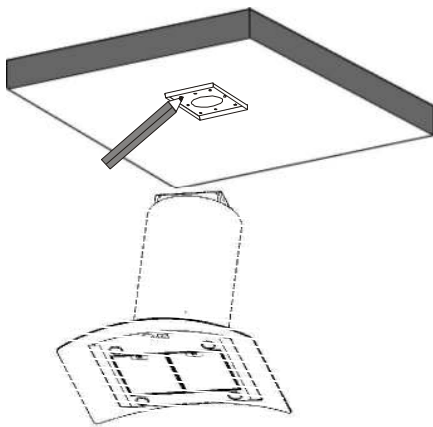

Island hood step 2

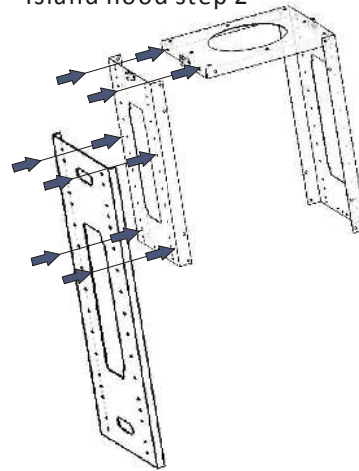

Island hood step 3

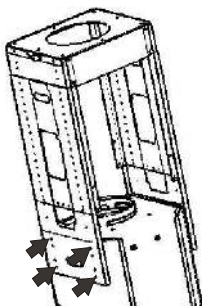

Island hood step 4

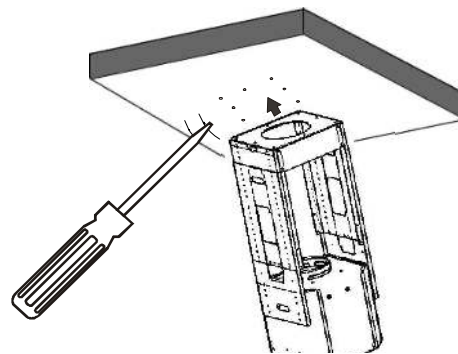

Note: The above installation guideline for references only, please contact local dealer for installation service.

Leveling Device

When mounting hood on the wall, the level can be adjusted by turning the two screws on the motor housing.

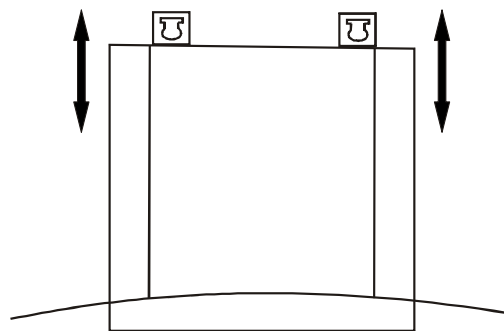
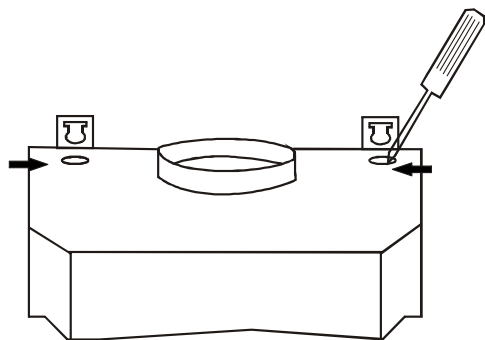

INSTALLATION ALTERNATIVES

The cooker hood can be installed in the following ways:

Circulating indoor air (A)

Outdoor venting (B)

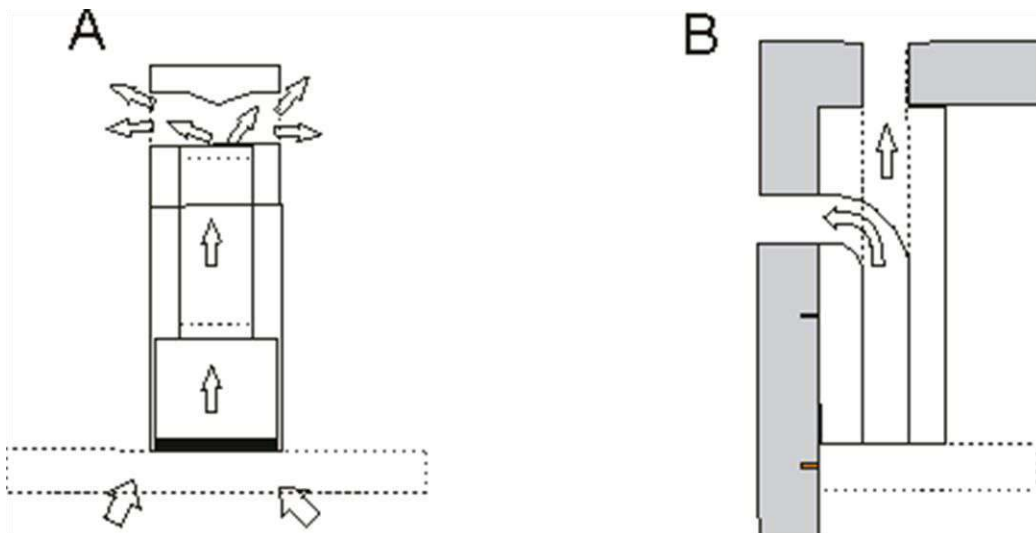

REMEMBER!

The distance between the top of the hob and the lowest part of the cooker hood must be at least 65 cm.

If a two-part connection tube is used, the lower section must sit outside the upper section.

Do not connect the cooker hood exhaust to a duct used to circulate hot air or vent steam from another appliance.

Always use protective gloves when installing the appliance!

USE AND CARE INSTRUCTIONS

Operations

- 1. For optimum performance in removing cooking odors, it is recommended that you turn on your range hood prior to cooking and you leave it operating for 15 min-utes after cooking.**
 - 2. Clean the surfaces of the range hood regularly using a non-abrasive detergent.**
 - 3. The anti-grease filters capture the grease particles sus-pended in the air. They will accumulate grease and dirt depending on the frequency of the use of your range/cook top.**
 - 4. In order to prevent a fire hazard, it is recommended that you clean the aluminum filter at least every 2 months**
- WARNINGS: Do not attempt to remove the fil-ters while the Range Hood is operating.**
 - Disconnect the electrical plug prior to any maintenance.**
 - This appliance is not intended for use by young children or infirm persons without supervision.**
 - There should be adequate ventilation in the room when the Range Hood is used at the same time as other fuel burning appliances.**

DESCRIPTION OF THE CONTROLS

A. Slide control

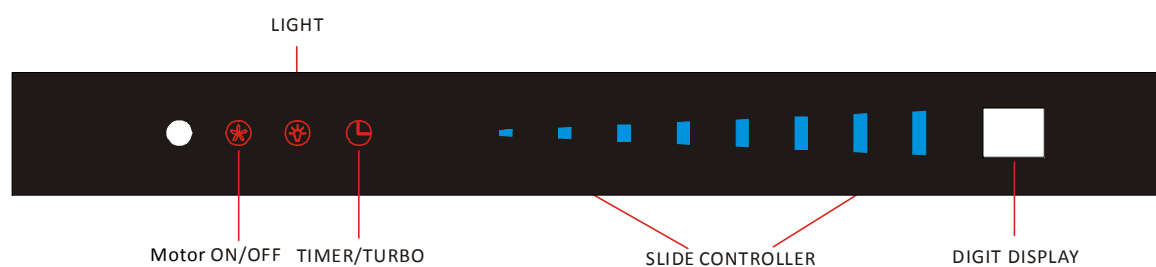

Motor:

Touch short time-blue indicator flash: default set in speed 1, by slide control can adjust to speed 2, 3

***turbo mode in optional hoods.**

After stop on one speed level, the light will flash 10sec.

Light:

Touch short time-blue indicator flash-default set in 25% lux, -by slide control can adjust to , 25%, 50%, 75% & 100% available.

Timer(Delay-off Function)

Touch short time-blue indicator flash-by slide control can adjust to, 5, 10, 15, 20 min delay off function available.

B. Touch Control

- For model COLLIDER

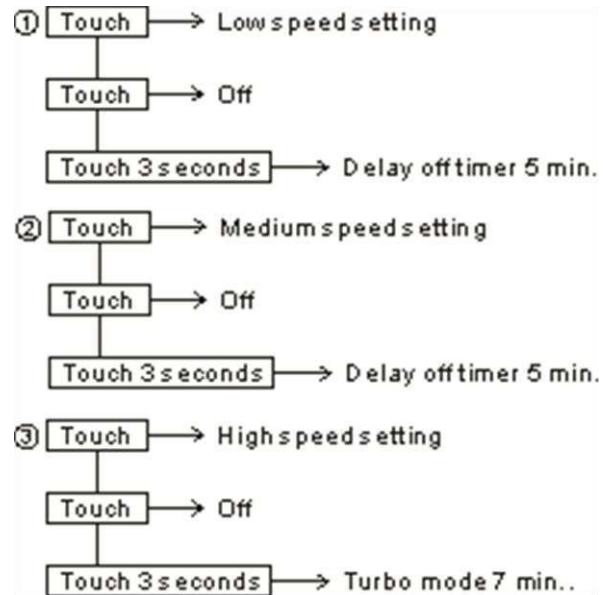

- For model V.I.P.



Remote controller

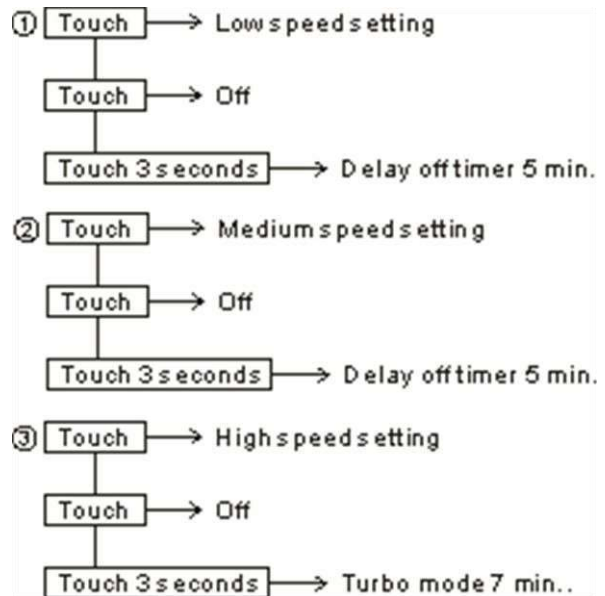

- For model AUVRORA

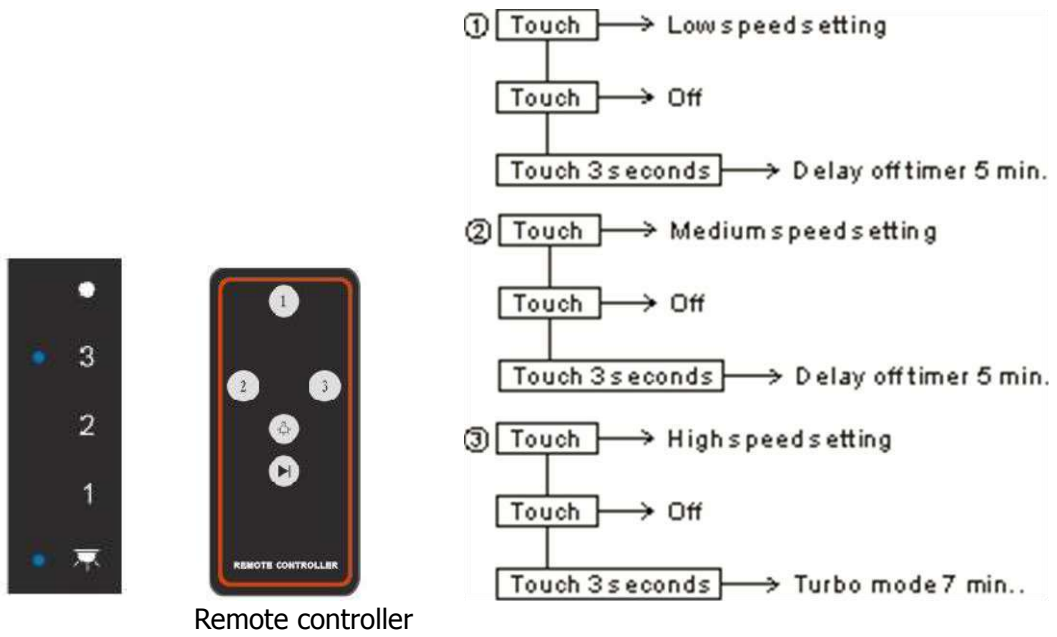

C. Push button control

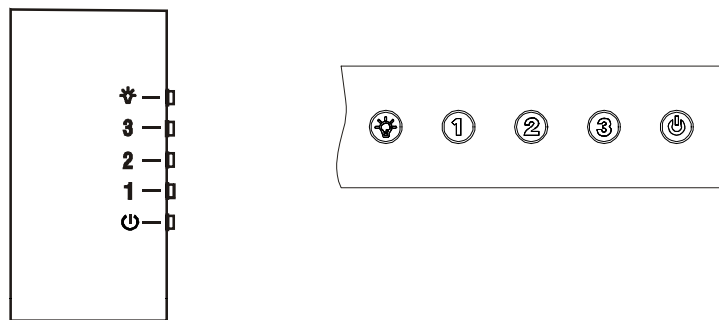

D. Electric control with LCD screen

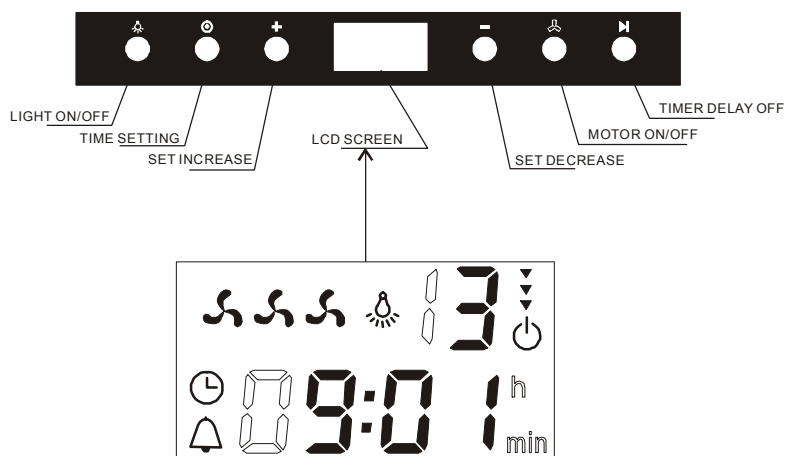

CARE AND CLEANING

General

Regular maintenance is required to ensure that the cooker hood functions properly. This is especially true of the grease and charcoal filters.

Clean the fan and other surfaces of the cooker hood regularly with a cloth dipped in denatured alcohol or a non-abrasive liquid cleaner.

The charcoal filter cleans the circulating air in the room. Such filters cannot be cleaned or recycled and must be replaced at least every four months. The speed at which the charcoal filter becomes saturated depends on how often the fan is used, the type of food that is cooked and how often the grease filter is cleaned.

To prevent the risk of fire and to ensure that the cooker hood functions properly, the grease filter must always be cleaned as instructed below when the display indicates the need or at least every two months.

Cleaning the grease filter

Remove the filter from the cooker hood and clean it in a solution of water and neutral cleaning liquid. Leave the filter to soak in the solution for a while.

- Rinse thoroughly with hot water and leave the filter to dry.

- The filter can also be cleaned in a dishwasher. The color of the grease filter may change after a few washes. This is normal.

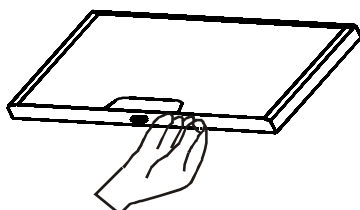

Replacing the charcoal filter (standard hood)

Replace the charcoal filter (standard hood) as follows:

Remove the grease filter.

Squeeze the clips on the charcoal filter and pull the charcoal filter back to remove it.

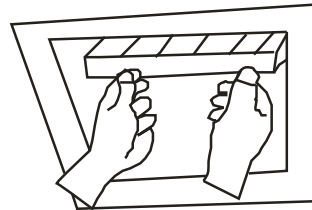

Replacing the charcoal filter (for hood with sloping surface)

1. Press the middle of the right edge of the glass cover to open it

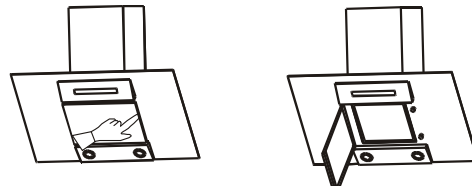

2. Remove the grease filter

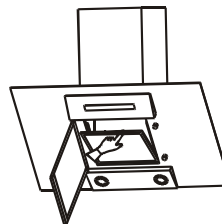

3. Squeeze the clips on the charcoal filter and pull the charcoal filter back to remove it.

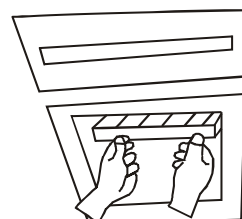

NB:

If you clean the grease filter in the dishwasher: load only the grease filter and no other items as food particles from dishes can fasten in the filter.

Emptying and cleaning the oil collector (For these hood fitted with oil collector)

The fan is fitted with a oil collector that collects oil from the fan blades and fan housing.

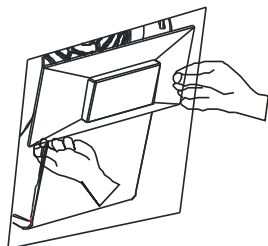

1. Remove the grease filter and the charcoal filter (if fitted).
2. Remove the oil collector and clean it in warm water with washing up liquid. It can also be cleaned in a dishwasher.

- DO NOT let dirt build up on the hood***
- DO NOT use steel wool or steel brushes to clean the hood***
- DO NOT leave salt solutions, disinfectants, bleaches or cleaning*** compounds on the hood for any length of time as they may damage the stainless steel. Rinse after use with clean water and wipe dry with a clean cloth.

Replacing the bulbs

Depending on your model of hood, there are two possible types of lighting, halogen and LED. The illumination is designed for use during cooking and not for prolonged general illumination of your kitchen. Prolonged use of the lights may reduce the life time of the bulbs.

WARNING: Do not touch or change light bulbs while the hood is operating. Wait until the bulb has cooled before removing.

Use only the same bulbs as the original specification. Re-placement lights are available through the dealers.

Halogen and LED Lights.

With the grease filter removed, from inside the hood press the light fixture out of its mounting bracket. Unplug the light from the wiring harness. Avoid direct contact between the lense and your hands.

Replace the damaged lamp by reversing the steps. Snap in place.

Replace the bulbs as follows:

1. Lift up and remove the light fitting with a screwdriver or other suitable tool.

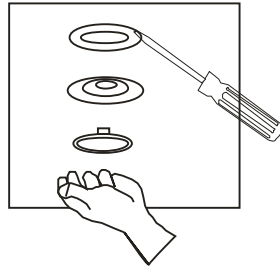

2. Remove the blown halogen bulb (if the fan has 4 bulbs = 10W, 2 bulbs = 20W). Remember that the bulb can be hot!
3. Insert the new halogen bulb.

If you touch the halogen bulb with your bare hands this may reduce its service life. Always use a glove or a cloth to avoid direct contact.

NB:

The light is only meant for use during cooking and not for illuminating the surroundings for longer periods. If the light is used for longer periods, this will considerably shorten the burn time of the bulbs.

Recycling

This appliance complies with European Community directive 2002/96/EC, Waste Electrical and Electronic Equipment (WEEE). By ensuring that this product is recycled responsibly, the user helps prevent possible negative impact on the environment.

NB:

Dispose of this product responsibly. Irresponsible disposal can result in negative environmental impact or personal injury.'

Under no circumstances may this extractor fan be disposed of as household waste. It must be taken to a recycling centre for electrical and electronic equipment.

This product must be disposed of in accordance with local legislation.

For more information on disposal, recycling and reuse of this product, contact your local authority, your household waste collection service or the store where you purchased the product



Hood Size:

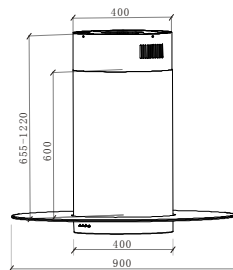
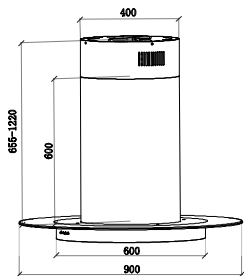
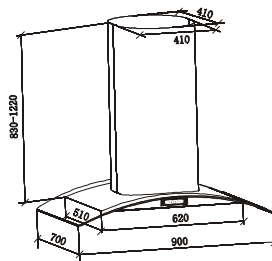
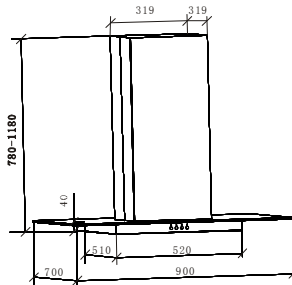
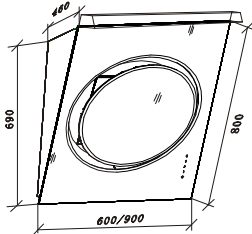
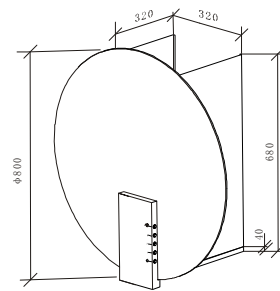
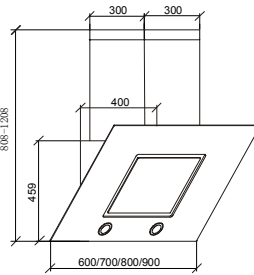
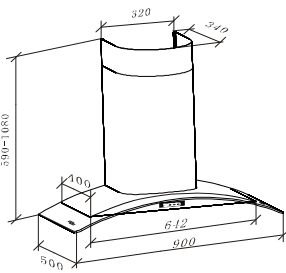
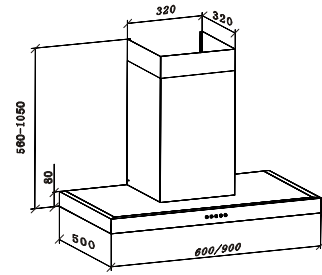
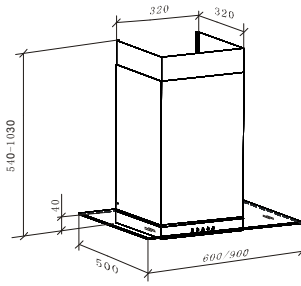
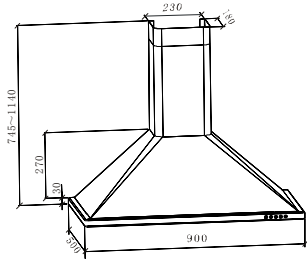

Trouble Shooting Guide

Problem	Possible Reason	Solution
Hood doesn't turn on.	No electrical supply.	Check the plug is connect-ed. Check the plug is connect-ed.
	Power cord is damaged	Contact technician service
Poor Airflow	Aluminum grease filters clogged	Clean the filters and replace when dry.
	Charcoal filters clogged. Re-circulating mode only.	Replace the charcoal filters.
Hood is vibrating	Hood is not secured in place	Check the installation of hood.Tighten mounting screws.
Motor running but no air flow	Butterfly valve jammed.	Contact technician service
Motor stops after a few minutes	High temperature safety device activated.	The kitchen is not sufficient-ly ventilated.
	The hood is installed too near the cooking surface.	The hood must be at least 61cm (24") from the stove
Strong cooking smell.	Fan speed too low	Use one of the higher set-tings.
	Charcoal filters not installed.	n re-circulating mode, char-coal filters must be installed.
Oil dripping onto stove.	Aluminum grease filter satu-rated.	Wash the aluminum grease filters
Whirring sound	Something in contact with fan blade.	Contact technician service
Lights are working but fan isn't		Contact technician service
Fan is working but lights are not		Contact technician service

GUARANTEE AND SERVICE!

Before booking a service call,read the Trouble Shooting Guide above , for more information on guarantee and service conditions, please contact local dealer.

Menara Lien Hoe (HQ)

Lot 11.3, 11th Floor,
Menara Lien Hoe,
8, Persiaran Tropicana,
47410 Petaling Jaya,
Selangor.

 03-780-577-25

 012-228 5727

 service@pacificamalaysia.com

 pacificam.my

 **pacificam**